



SPECTRUM

SYSTEMENTWICKLUNG MICROELECTRONIC GMBH

M3i.41xx - 14 bit transient recorder up to 400 MS/s

- Up to 400 MS/s on one channel or 250 MS/s on two channels
- Simultaneously sampling on all channels
- Separate monolithic ADC and amplifier per channel
- 6 input ranges: ± 100 mV up to ± 5 V
- Up to 2 synchronous digital channels with multi-purpose I/O
- Up to 2 GSample (4 GByte) on-board memory
- 128 MSample standard memory installed
- Window, re-arm, OR/AND trigger
- Synchronization of up to 8 cards per system
- Options: Multiple Recording, Timestamps



PCI / PCI-X

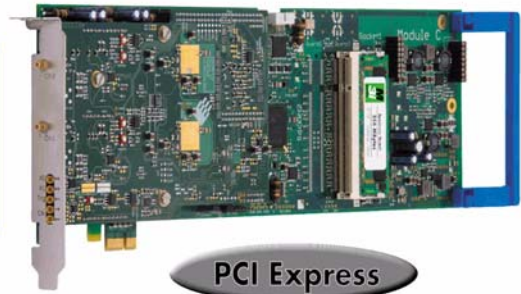

PCI Express

- 66 MHz 32 bit PCI-X interface
- 5V / 3.3V PCI compatible
- 100% compatible to conventional PCI > V2.1
- Sustained streaming mode up to 245 MB/s

- 2,5 GBit x1 PCIe Interface
- Works with x1/x4/x8/x16* PCIe slots
- Software compatible to PCI
- Sustained streaming mode up to 160 MB/s

Operating Systems	Recommended Software	Drivers
<ul style="list-style-type: none"> • Windows 2k, XP, Vista • Linux Kernel 2.6 • Both 32 and 64 bit 	<ul style="list-style-type: none"> • Visual Basic, Visual C++, Borland C++ Builder, GNU C++, Borland Delphi, VB.NET, C#, J# • SBench 6 	<ul style="list-style-type: none"> • MATLAB • LabVIEW • LabWindows/CVI • Agilent VEE

Model	1 channel	2 channels
M3i.4110	100 MS/s	
M3i.4111	100 MS/s	100 MS/s
M3i.4120	250 MS/s	
M3i.4121	250 MS/s	250 MS/s
M3i.4140	400 MS/s	
M3i.4142	400 MS/s	250 MS/s

General Information

The 6 models of the M3i.41xx series are designed for the fast and high quality data acquisition. Each of the input channels has its own monolithic A/D converter and its own programmable input amplifier. This allows to record signals simultaneously on both channels with 14 bit resolution without any phase delay between them. The extremely large on-board memory allows long time recording even with the highest sampling rates. All boards of the M3i.41xx series may use the whole installed on-board memory for the currently activated number of channels. A FIFO mode is also integrated on the board. This allows the acquisition of data continuously for online processing or for data storage to hard disk.

*Some x16 PCIe slots are for the use of graphic cards only and can not be used for other cards.

Software Support

Windows drivers

The cards are delivered with drivers for Windows 2000, XP, XP64, Vista and Vista64. Programming examples for Visual C++, Borland C++ Builder, LabWindows/CVI, Borland Delphi, Visual Basic, VB.NET, C# and J# are included.

Linux Drivers



All cards are delivered with full Linux support. Pre compiled kernel modules are included for the most common distributions like RedHat, Fedora, Suse or Debian. The Linux support includes SMP systems, 32 bit and 64 bit systems, versatile programming examples for Gnu C++ as well as the possibility to get the driver sources for own compilation.

SBench

A full licence of SBench the easy-to-use graphical operating software for the Spectrum cards is included in the delivery. The version 6 is running under Windows as well as under Linux (KDE and GNOME).

Third-party products

A lot of third-party products are supported as an option. Choose between LabVIEW, MATLAB and Agilent VEE. All drivers come with examples and detailed documentation.

Hardware features and options

PCI/PCI-X



The cards with PCI/PCI-X bus connector use 32 Bit and up to 66 MHz clock rate for data transfer. They are 100% compatible to Conventional PCI > V2.1. The universal interface allows the use in PCI slots with 5 V I/O and 3.3 V I/O voltages as well as in PCI-

X or PCI 64 slots. The maximum sustained data transfer rate is 245 MByte/s per bus segment.

PCI Express



The cards with PCI Express use a x1 PCIe connector. They can be used in PCI Express x1/x4/x8/x16 slots, except special graphic card slots, and are 100% software compatible to Conventional PCI > V2.1. The maximum sustained data transfer rate is

160 MByte/s per slot.

Input Amplifier

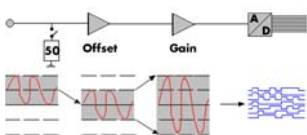

The analog inputs can be adapted to real world signals using a wide variety of settings that are individual for each channel. By using software commands the input termination can be changed

between 50 Ohm and 1 MOhm, one can select a matching input range and the signal offset can be compensated by programmable AC coupling.

Software selectable input path

For each of the analog channels the user has the choice between two analog input paths. The „Buffered“ path offers the highest flexibility when it comes to input ranges and termination. A software programmable 50 Ohm and 1 MOhm termination also allows to

connect standard oscilloscope probes to the card. The „50 Ohm“ path on the other hand provides the highest bandwidth and the best signal integrity with a fewer number of input ranges and a fixed 50 Ohm termination.

Software selectable lowpass filter

Each analog channel contains a software selectable low-pass filter to limit the input bandwidth. Reducing the analog input bandwidth results in a lower total noise and can be useful especially with low voltage input signals.

Automatic on-board calibration

All of the channels are calibrated in factory before the board is shipped. To compensate for different variations like PC power supply, temperature and aging, the software driver provides routines for an automatic onboard offset and gain calibration of all input ranges of the „Buffered“ path. All the cards contain a high precision on-board calibration reference.

Digital inputs

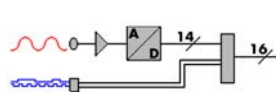

This option acquires additional synchronous digital channels phase-stable with the analog data. A maximum of 2 additional digital inputs available per card using the multi-purpose I/O lines.

Ring buffer mode

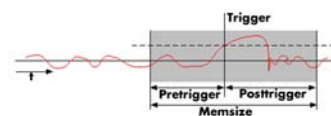

The ring buffer mode is the standard mode of all oscilloscope boards. Data is written in a ring memory of the board until a trigger event is

detected. After the event the posttrigger values are recorded. Because of this continuously recording into a ring buffer there are also samples prior to the trigger event visible: Pretrigger = Memsize - Posttrigger.

FIFO mode

The FIFO mode is designed for continuous data transfer between measurement board and PC memory (up to 245 MB/s on a PCI-X slot, up to 125 MB/s on a PCI slot and up to 160 MB/s on a PCIe slot) or hard disk. The control of the data stream is done automatically by the driver on interrupt request. The complete installed on-board memory is used for buffer data, making the continuous streaming extremely reliable.

Channel trigger

The data acquisition boards offer a wide variety of trigger modes. Besides the standard signal checking for level and edge as known from oscilloscopes it's also possible to define a window trigger. All trigger modes can be combined with a re-arming mode (for accurate trigger recognition on noisy signals) the AND/OR conjunction of different trigger events is possible.

External trigger input

All boards can be triggered using an external analog or digital signal. It's possible to use positive or negative edge. As two analog comparators are used, one can also define a window trigger, a hysteresis trigger or a re-arm trigger.

Universal Multi-Purpose I/Os



All M3i cards offer two universal multi-purpose I/O lines, which can be separately programmed as either input or output. These lines can be used as additional TTL trigger inputs for more complex trigger conditions. Additionally these lines can also be used to acquire digital data synchronously with the analog data (see Digital Inputs). When used as outputs, these lines can be used to output card status signals like trigger-armed or to output the trigger to synchronize external equipment.

Multiple Recording

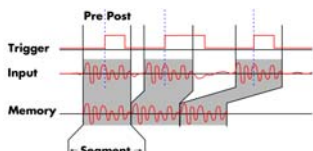

The Multiple Recording option allows the recording of several trigger events with an extremely short re-arming time. The hardware doesn't need to be restarted in between. The on-board memory is divided in several segments of the same size. Each of them is filled with data if a trigger event occurs. Pre- and posttrigger of the segments can be programmed. The number of acquired segments is only limited by the used memory and is unlimited when using FIFO mode.

The Multiple Recording option allows the recording of several trigger events with an extremely short re-arming time. The hardware doesn't need to be restarted in between. The on-board memory is divided in several segments of the same size. Each of them is filled with data if a trigger event occurs. Pre- and posttrigger of the segments can be programmed. The number of acquired segments is only limited by the used memory and is unlimited when using FIFO mode.

ABA mode

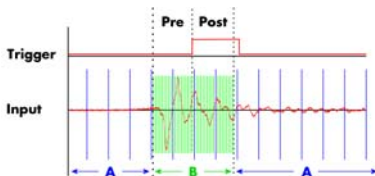

The exact position of the trigger events is stored as timestamps in an extra memory.

The optional ABA mode combines slow continuous data recording with fast acquisition on trigger events. The ABA mode works like a slow data logger combined with a fast digitizer. The

Timestamp

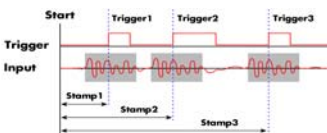

externally synchronised to a radio clock, or a GPS receiver. With this option acquisitions of systems on different locations can be set in a precise time relation.

The timestamp option writes the time positions of the trigger events in an extra memory. The timestamps are relative to the start of recording, a defined zero time, externally synchronised to a radio clock, or a GPS receiver. With this option acquisitions of systems on different locations can be set in a precise time relation.

External clock input and output

Using a dedicated connector a sampling clock can be fed in from an external system. Additionally it's also possible to output the internally used sampling clock on a separate connector to synchronize external equipment to this clock.

Reference clock

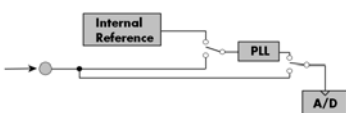

The option to use a precise external reference clock (normally 10 MHz) is necessary to synchronize the board for high-quality measurements with external equipment (like a signal source). It's also possible to enhance the quality of the sampling clock in this way. The driver automatically generates the requested sampling clock from the fed in reference clock.

The option to use a precise external reference clock (normally 10 MHz) is necessary to synchronize the board for high-quality measurements with external equipment (like a signal source). It's also possible to enhance the quality of the sampling clock in this way. The driver automatically generates the requested sampling clock from the fed in reference clock.

Star-Hub



The star-hub is an additional module allowing the phase stable synchronisation of up to 8 boards in one system. Independent of the number of boards there is no phase delay between all channels. The star-hub distributes trigger and clock information between all boards. As a result all connected boards are running with the same clock and the same trigger. All trigger sources can be combined with a logical OR allowing all channels of all cards to be trigger source at the same time.

BaseXIO (enhanced timestamps)



The BaseXIO option offers 8 asynchronous digital I/O lines on the base card, which are available on a separate bracket as SMB connectors. The direction can be selected by software in groups of four.

In addition one of the I/O lines can be used as reference clock for the Timestamp counter.

Technical Data

Analog Inputs

Resolution	14 bit
Differential non linearity (DNL)	≤ 1.5 LSB (ADC)
Integral non linearity (INL)	≤ 3 LSB (ADC)
Offset error	can be calibrated by user
Gain error	can be calibrated by user
Programmable input offset	TBD
Crosstalk 1 MHz signal, 50 Ohm term	TBD
Input signal with 50 Ohm termination	max 5 Vrms
Analog Input impedance (high impedance path)	50 Ohm / 1 MOhm 25 pF
Analog Input impedance (high bandwidth path)	50 Ohm TBD
Over voltage protection (range ≤ ±1 V)	TBD / TBD (AC / DC coupled)
Over voltage protection (range > ±1 V)	TBD / TBD (AC / DC coupled)
Connector (analog inputs)	3 mm SMB male

Trigger

Multiple Recording: re-arming time	TBD
Max Pretrigger at Multi and FIFO	8192 Samples as sum of all active channels
Internal trigger accuracy	1 Sample
Channel trigger resolution	10 bits
Trigger output delay	TBD
External trigger type	Analog window comparator
External trigger connector	MMCX female
External trigger max voltage 1 MOhm	TBD / TBD (AC / DC coupled)
External trigger max voltage 50 Ohm	TBD / TBD (AC / DC coupled)
External trigger impedance	50 Ohm / 1 MOhm TBD
External trigger accuracy	1 Sample
External trigger output impedance	50 Ohm
External trigger output levels	Low ≤ 0.4 V, High ≥ 2.4 V
External trigger output type	TTL compatible for high-impedance loads
External trigger output drive strength	Capable of driving 50 Ohm load

Power consumption (max speed)

	PCI / PCI-X		PCI EXPRESS	
	3,3 V	5 V	3,3 V	12 V
M3i.41x0 (128 MS memory)	TBD	TBD	TBD	TBD
M3i.41x1 (128 MS memory)	TBD	TBD	TBD	TBD
M3i.41x2 (128 MS memory)	TBD	TBD	TBD	TBD
M3i.41x2 (2 GS memory), max. power	TBD	TBD	TBD	TBD

Max channels with Star-Hub

	SH8
M3i.41x0	8
M3i.41x1	16

BaseXIO (Option)

BaseXIO Connector (extra bracket)	8 x SMB male (8 x MMCX female internal)
BaseXIO input	TTL compatible: Low ≤ 0.8 V, High ≥ 2.0 V
BaseXIO input maximum voltage	-0.5 V up to +5.5 V
BaseXIO output levels	TTL compatible: Low ≤ 0.4 V, High ≥ 2.4 V
BaseXIO output drive strength	32 mA maximum current

Multi purpose digital I/O

No of multi purpose lines	two
Digital inputs: input impedance	TBD
Digital inputs delay to analog sample	0 Samples
Maximum voltage	-0.3 V up to +5.5 V
Input voltage	Low ≤ 0.8 V, High ≥ 2.0 V
Connector	MMCX female
Additional usage of multi purpose I/O	additional TTL trigger lines, trigger output, event output

Certifications, Compliances, Warranty

EMC Immunity	Compliant with CE Mark
EMC Emission	Compliant with CE Mark
Product warranty	2 years starting with the day of delivery
Software and firmware updates	Life-time, free of charge

Clock

Internal clock range	TBD to max (see table below)
Internal clock accuracy	20 ppm
Internal clock setup granularity	TBD
Internal clock setup granularity example	TBD
External clock input connector/coupling	MMCX female, AC coupled
Reference clock: external clock range	≥ 1.0 MHz and ≤ 1.0 GHz
External clock reference range	1 MS/s to max (see table below)
External clock delay to internal clock	TBD
External clock input type	single-ended, 3.3V LVPECL
External clock input	TBD
External clock maximum voltage	TBD
External clock output connector/coupling	MMCX female, AC coupled
External clock output type	single-ended, 3.3V LVPECL
External clock output drive strength	Capable of driving 50 ohm load

Environmental and Physical details

Dimension (PCB only)	312 mm x 107 mm (full PCI length)
Width (Standard)	1 full size slot
Width (star-hub 8)	2 full size slots
Width (with BaseXIO)	1 full size slots + 1 half size slot
Weight (depending on options/channels)	TBD
Warm up time	10 minutes
Operating temperature	0°C - 50°C
Storage temperature	-10°C - 70°C
Humidity	10% to 90%

PCI / PCI-X specific details

PCI / PCI-X bus slot type	32 bit 33/66 MHz
PCI / PCI-X bus slot compatibility	32/64 bit, 33-133 MHz, 3,3 and 5 V I/O

PCI EXPRESS specific details

PCIe slot type	x1
PCIe slot compatibility	x1/x4/x8/x16*

*Some x16 PCIe slots are for graphic cards only and can not be used for other cards.

Software programmable parameters

Input Ranges (Buffered path)	±100 mV, ±250 mV, ±500m V, ±1 V, ±2.5 V, ±5 V
Input Ranges (50 Ohm path)	±500m V, ±1 V, ±2.5 V, ±5 V
Analog input impedance	50 Ohm / 1M Ohm (Buffered path)
Analog input coupling	AC / DC
Input Offset	TBD
Clock mode	Internal, external reference clock, sync
External trigger impedance	50 Ohm / 1 MOhm
External trigger coupling	AC / DC
Trigger mode	Channel, Extern, SW, Auto, Window, Re-Arm, Or/And, Delay
Trigger level (channel)	10 bit resolution: 1/1024 to 1023/1024 of input range
Trigger edge	Rising edge, falling edge or both edges
Trigger delay	0 to 32G samples in steps of 8 samples
Memory depth	8 up to [installed memory / number of active channels] in steps of 8
Posttrigger	0 up to 4 GSamples in steps of 8
Multiple Recording segment size	16 up to [installed memory / 2 / active channels] in steps of 16
Multiple Recording pretrigger	0 up to [8k samples / number of active channels]
Channel selection	1 or 2

Dynamic Parameters

	M3i.4110		M3i.4111		M3i.4120		M3i.4121		M3i.4140		M3i.4142	
max internal clock	100 MS/s		100 MS/s		250 MS/s		250 MS/s		400 MS/s		400 MS/s	
-3 dB bandwidth (buffered path)	DC to 50 MHz		DC to 50 MHz		DC to 90 MHz		DC to 90 MHz		DC to 125 MHz		DC to 125 MHz	
-3 dB bandwidth (50 ohm path, BW limit disabled)	DC to 50 MHz		DC to 50 MHz		DC to 125 MHz		DC to 125 MHz		DC to 200 MHz		DC to 200 MHz	
-3 dB bandwidth (50 ohm path, BW limit enabled)	DC to 20 MHz		DC to 20 MHz		DC to 20 MHz		DC to 20 MHz		DC to 20 MHz		DC to 20 MHz	
Zero noise level (< 125 MS/s)	< TBD LSB rms		< TBD LSB rms		< TBD LSB rms		< TBD LSB rms		< TBD LSB rms		< TBD LSB rms	
Test - sampling rate	100 MS/s		100 MS/s		250 MS/s		250 MS/s		400 MS/s		400 MS/s	
Test signal frequency	TBD	TBD	TBD	TBD	TBD	TBD	TBD	TBD	TBD	TBD	TBD	TBD
Bandwidth limit	on off		on off		on off		on off		on off		on off	
SNR (typ) (dB)	TBD	TBD	TBD	TBD	TBD	TBD	TBD	TBD	TBD	TBD	TBD	TBD
THD (typ) (dB)	TBD	TBD	TBD	TBD	TBD	TBD	TBD	TBD	TBD	TBD	TBD	TBD
SFDR (typ), incl. harm. (dB)	TBD	TBD	TBD	TBD	TBD	TBD	TBD	TBD	TBD	TBD	TBD	TBD
SFDR (typ), excl. harm. (dB)	TBD	TBD	TBD	TBD	TBD	TBD	TBD	TBD	TBD	TBD	TBD	TBD
SINAD (typ) (dB)	TBD	TBD	TBD	TBD	TBD	TBD	TBD	TBD	TBD	TBD	TBD	TBD
ENOB based on SNR (bit)	TBD	TBD	TBD	TBD	TBD	TBD	TBD	TBD	TBD	TBD	TBD	TBD
ENOB based on SINAD (bit)	TBD	TBD	TBD	TBD	TBD	TBD	TBD	TBD	TBD	TBD	TBD	TBD

Dynamic parameters are measured at ± 1 V input range (if no other range is stated) in the 50 Ohm terminated path with the samplerate specified in the table. Measured parameters are averaged 20 times to get typical values. Test signal is a pure sine wave of the specified frequency with > 99% amplitude. SNR and RMS noise parameters may differ depending on the quality of the used PC. SNR = Signal to Noise Ratio, THD = Total Harmonic Distortion, SFDR = Spurious Free Dynamic Range, SINAD = Signal Noise and Distortion, ENOB = Effective Number of Bits. For a detailed description please see application note 002.

Hardware block diagram

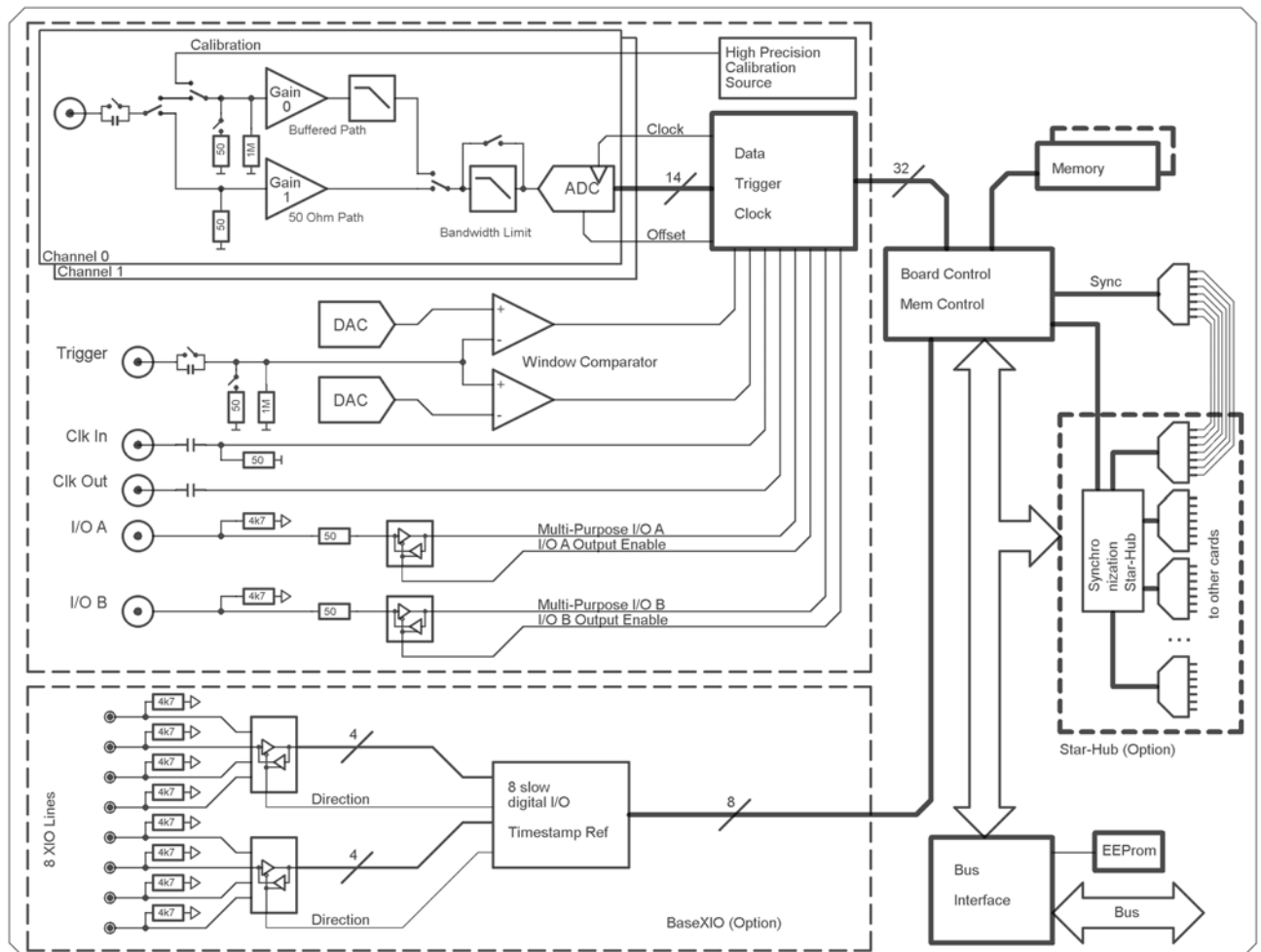

Order Information

PCI/PCI-X	Order no.	Standard mem	1 channel	2 channels
	M3i.4110	128 MSample	100 MS/s	
	M3i.4111	128 MSample	100 MS/s	100 MS/s
	M3i.4120	128 MSample	250 MS/s	
	M3i.4121	128 MSample	250 MS/s	250 MS/s
	M3i.4140	128 MSample	400 MS/s	
	M3i.4142	128 MSample	400 MS/s	250 MS/s
PCI Express	Order no.	Standard mem	1 channel	2 channels
	M3i.4110-exp	128 MSample	100 MS/s	
	M3i.4111-exp	128 MSample	100 MS/s	100 MS/s
	M3i.4120-exp	128 MSample	250 MS/s	
	M3i.4121-exp	128 MSample	250 MS/s	250 MS/s
	M3i.4140-exp	128 MSample	400 MS/s	
	M3i.4142-exp	128 MSample	400 MS/s	250 MS/s
Memory	Order no.	Option		
	M3i.xxxx-256MS	Memory upgrade to 256 MSample (512 MB) total memory		
	M3i.xxxx-512MS	Memory upgrade to 512 MSample (1 GB) total memory		
	M3i.xxxx-1GS	Memory upgrade to 1 GSample (2 GB) total memory		
	M3i.xxxx-2GS	Memory upgrade to 2 GSample (4 GB) total memory		
Options	Order no.	Option		
	M3i.xxxx-mr	Option Multiple Recording		
	M3i.xxxx-mt	Option pack including Multiple Recording, Timestamp		
	M3i.xxxx-mtab	Option pack including Multiple Recording, Timestamp, ABA mode		
	M3i.xxxx-SH4	Synchronization Star-Hub for up to 4 cards, only 1 slot width		
	M3i.xxxx-SH8	Synchronization Star-Hub for up to 8 cards, 2 slots width		
	M3i.xxxx-bxio	Option BaseXIO: 8 digital I/O lines usable as asynchronous I/O and timestamp ref-clock, additional bracket with 8 SMB connectors		
	M3i-upgrade	Upgrade for M3i.xxxx: later installation of option -bxio		
Cables	Order no.	Option		
	Cab-1m-9m-80	Adapter cable MMCX male to BNC male, 80 cm (for all other signals)		
	Cab-1m-9f-80	Adapter cable MMCX male to BNC female, 80 cm (for all other signals)		
	Cab-1m-9m-200	Adapter cable MMCX male to BNC male, 200 cm (for all other signals)		
	Cab-1m-9f-200	Adapter cable MMCX male to BNC female, 200 cm (for all other signals)		
	Cab-1m-9f-5	Adapter cable MMCX male to BNC female, 5 cm (short cable especially for oscilloscope probes)		
	Cab-3f-9m-80	Adapter cable SMB female to BNC male, 80 cm (for analog inputs)		
	Cab-3f-9f-80	Adapter cable SMB female to BNC female, 80 cm (for analog inputs)		
	Cab-3f-3f-80	Adapter cable SMB female to SMB female, 80 cm (for analog inputs)		
	Cab-3f-9m-200	Adapter cable SMB female to BNC male, 200 cm (for analog inputs)		
	Cab-3f-9f-200	Adapter cable SMB female to BNC female, 200 cm (for analog inputs)		
	Cab-3f-3f-200	Adapter cable SMB female to SMB female, 200 cm (for analog inputs)		
	Cab-3f-9f-5	Adapter cable SMB female to BNC female, 5 cm (short cable especially for oscilloscope probes)		
Drivers	Order no.	Option		
	M3i.xxxx-ml	MATLAB driver for all M3i cards		
	M3i.41xx-lv	LabVIEW driver for all M3i.41xx cards		
	M3i.41xx-vee	Agilent VEE driver for all M3i.41xx cards		

Technical changes and printing errors possible